



**GYNECOLOGY/  
OBSTETRICAL  
INSTRUMENTS**



**Cusco vaginal speculum**  
16-101-01 75 x 17 mm  
Side Screw



**CUSCO**  
16-102-01 75 x 32 mm  
16-103-02 85 x 35 mm  
16-104-03 100 x 35 mm  
Side Screw



**Cusco vaginal speculum**  
16-105-01 75 mm x 32 mm  
16-106-02 80 mm x 35 mm  
16-107-03 100 mm x 37 mm  
Center Screw



**CUSCO**  
16-108-01 90 x 22 mm  
16-109-02 100 x 25 mm  
16-110-03 105 x 27 mm  
Swiss pattern



**Grave vaginal speculum**  
16-111-01 75 mm x 20 mm  
16-112-02 95 mm x 35 mm  
16-113-03 115 mm x 35 mm



**Pederson vaginal speculum**  
16-114-01 75 mm x 13 mm  
16-115-02 100 mm x 22 mm  
16-116-03 120 mm x 25 mm

## VAGINAL SPECULA

*Scheidenspekula* | *Espéculos vaginales*  
*Spéculums vaginaux* | *Specoli vaginali*



**Semm vaginal speculum**  
16-117-01 90 mm x 14 / 18 mm  
16-118-02 100 mm x 17 / 20 mm  
16-119-03 110 mm x 25 / 30 mm



**Vaginal Speculum Cusco**  
16-120-01 Extra Small  
16-121-02 Small  
16-122-03 Medium  
16-123-04 Medium Extra long  
16-124-05 Large



**Trelat vaginal speculum**  
16-125-01 85 mm x 30 mm  
16-126-02 95 mm x 35 mm  
16-127-03 115 mm x 43 mm



**WINTERTON**  
16-128-01  
140mm x 25mm

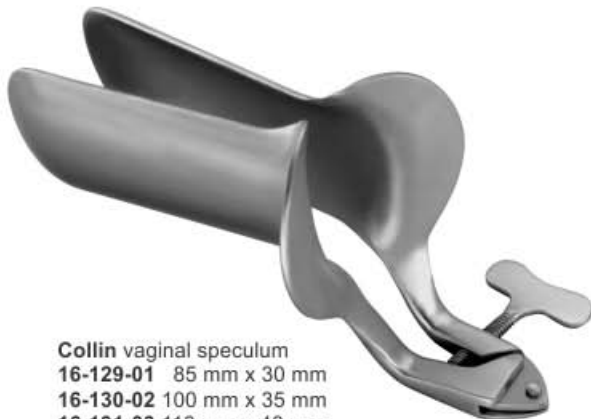

**Collin vaginal speculum**  
16-129-01 85 mm x 30 mm  
16-130-02 100 mm x 35 mm  
16-131-03 110 mm x 40 mm

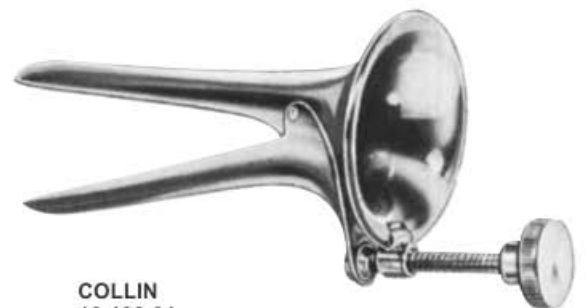

**COLLIN**  
16-132-01  
55 x 10 mm

## VAGINAL SPECULA

Scheidenspekula | Espéculos vaginales  
Spéculums vaginaux | Specoli vaginali

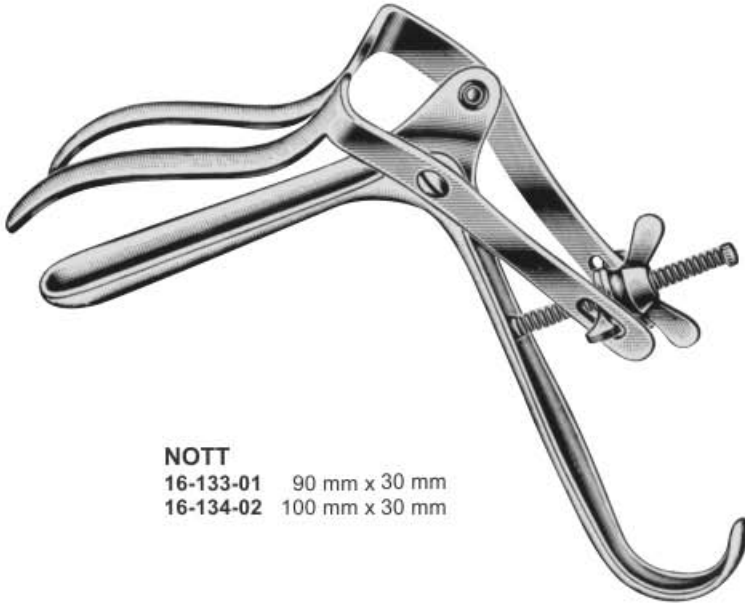

### NOTT

16-133-01 90 mm x 30 mm  
16-134-02 100 mm x 30 mm

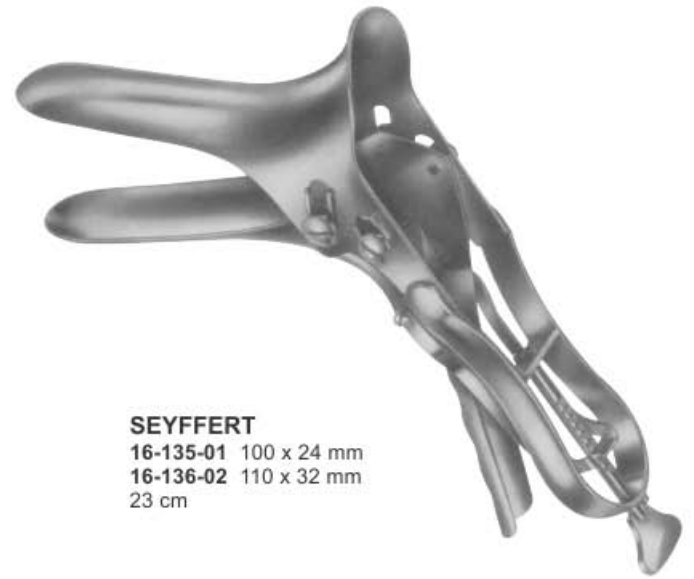

### SEYFFERT

16-135-01 100 x 24 mm  
16-136-02 110 x 32 mm  
23 cm



### DE VILBISS

16-137-01  
4 x 27 mm  
102 mm x 32 mm  
Medium



**Graves** Vaginal  
Speculum Leep / Lietz  
16-138-01 Small  
16-139-02 Medium  
16-140-03 Large  
16-141-04 X-large



**Pederson** Vaginal  
Speculum Leep / Lietz  
16-142-01 Small  
16-143-02 Medium  
16-144-03 Large  
16-145-04 X-Large



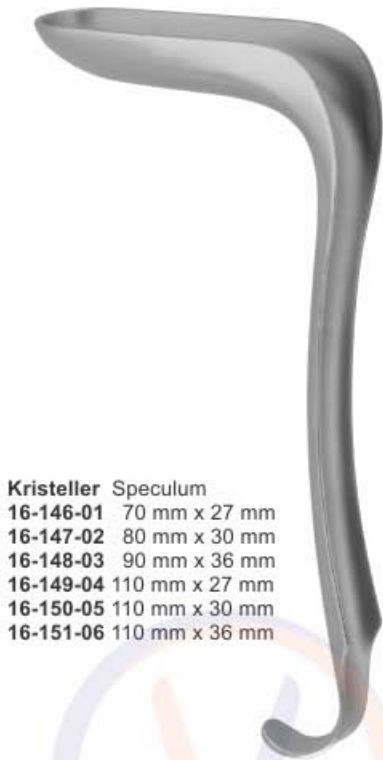

**Kristeller Speculum**  
**16-146-01** 70 mm x 27 mm  
**16-147-02** 80 mm x 30 mm  
**16-148-03** 90 mm x 36 mm  
**16-149-04** 110 mm x 27 mm  
**16-150-05** 110 mm x 30 mm  
**16-151-06** 110 mm x 36 mm



**Kristeller Retractor**  
**16-152-11** 75 mm x 23 mm  
**16-153-12** 85 mm x 26 mm  
**16-154-13** 100 mm x 32 mm  
**16-155-14** 115 mm x 23 mm  
**16-156-15** 115 mm x 26 mm  
**16-157-16** 115 mm x 32 mm



**Kristeller Speculum & Retractor**  
**16-158-21** 75 mm x 23 mm  
**16-159-22** 85 mm x 26 mm  
**16-160-23** 100 mm x 32 mm  
**16-161-24** 115 mm x 23 mm  
**16-162-25** 115 mm x 26 mm  
**16-163-26** 115 mm x 32 mm

**KUMMAS**  
CORPORATION



**Kristeller Speculum**  
**16-164-01** 105 mm x 18 mm  
**16-165-02** 105 mm x 21 mm  
 Speculum tapered, for virgins



**Kristeller Retractor**  
**16-166-11** 110 mm x 14 mm  
**16-167-12** 115 mm x 17 mm



**Kristeller Speculum & Retractor**  
**16-168-21** 110 mm x 14 mm  
**16-169-22** 115 mm x 17 mm



**Kallmorgen Speculum**  
16-170-01 70 mm x 40 mm  
16-171-02 90 mm x 40 mm



**Kallmorgen & Retractor**  
16-172-11 70 mm x 33 mm  
16-173-12 90 mm x 33 mm



**Kallmorgen Speculum & Retractor**  
16-174-21 70 mm x 33 mm  
16-175-22 90 mm x 33 mm



**Jackson Retractor**  
16-176-01 75 mm x 35 mm  
16-177-02 75 mm x 40 mm  
16-178-03 90 mm x 35 mm  
16-179-04 90 mm x 40 mm  
16-180-05 100 mm x 35 mm  
16-181-06 100 mm x 40 mm



**Sims Speculum & Retractor**  
16-182-00 Set/3 Pcs  
16-183-01 70 mm x 25 mm / 30 mm  
16-184-02 75 mm x 30 mm / 35 mm  
16-185-03 80 mm x 35 mm / 40 mm

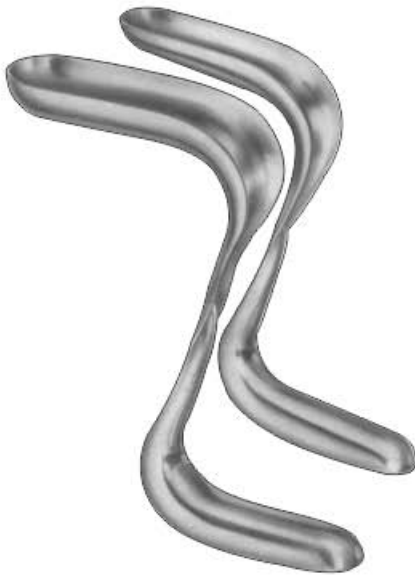

**BRIESKY**

**16-186-01**  
72x25 mm / 77x30 mm  
**16-187-02**  
75x30 mm / 92x38 mm  
17 cm



**MATHIEU Vaginal Speculum**

**16-188-01** 95x17-30mm  
**16-189-02** 100x13-23mm  
**16-190-03** 100x17-30mm  
21 cm

← **MATHIEU Vaginal Speculum** →

and Retractors complete set  
**16-191-21** 95x17-30mm  
**16-192-22** 100x13-23mm  
**16-193-23** 100x17-30mm  
22 cm



**MATHIEU Vaginal Retractor**

**16-194-11** 95x17-26mm  
**16-195-12** 100x11-21mm  
**16-196-13** 100x15-27mm  
22 cm



**DOYEN VAGINAL SPECULUM**

**16-197-01** 70x30mm  
24 cm



**DOYEN POZZI**

Retractor  
25.5cm  
**16-198-01** 4.5mm x 5mm  
**16-199-02** 4.5mm x 9mm  
**16-200-03** 4.5mm x 11.5mm



**DOYEN Vaginal Flat Retractor**

23cm  
**16-201-01**  
1.75mm x 10mm

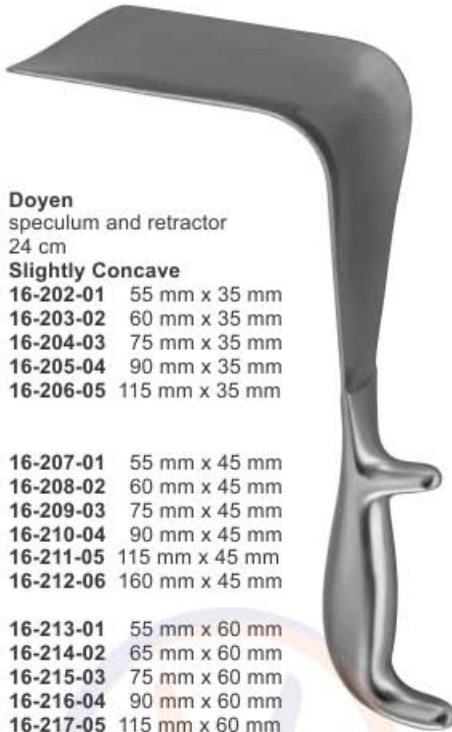

**Doyen**  
speculum and retractor  
24 cm

**Slightly Concave**

- 16-202-01 55 mm x 35 mm
- 16-203-02 60 mm x 35 mm
- 16-204-03 75 mm x 35 mm
- 16-205-04 90 mm x 35 mm
- 16-206-05 115 mm x 35 mm

- 16-207-01 55 mm x 45 mm
- 16-208-02 60 mm x 45 mm
- 16-209-03 75 mm x 45 mm
- 16-210-04 90 mm x 45 mm
- 16-211-05 115 mm x 45 mm
- 16-212-06 160 mm x 45 mm

- 16-213-01 55 mm x 60 mm
- 16-214-02 65 mm x 60 mm
- 16-215-03 75 mm x 60 mm
- 16-216-04 90 mm x 60 mm
- 16-217-05 115 mm x 60 mm
- 16-218-06 160 mm x 60 mm



**Doyen**  
speculum and retractor  
24 cm

**Medium Concave**

- 16-219-01 55 mm x 35 mm
- 16-220-02 75 mm x 35 mm
- 16-221-03 90 mm x 35 mm
- 16-222-04 115 mm x 35 mm

- 16-223-01 55 mm x 45 mm
- 16-224-02 60 mm x 45 mm
- 16-225-03 75 mm x 45 mm
- 16-226-04 90 mm x 45 mm
- 16-227-05 115 mm x 45 mm

- 16-228-01 55 mm x 60 mm
- 16-229-02 60 mm x 60 mm
- 16-230-03 75 mm x 60 mm
- 16-231-04 90 mm x 60 mm
- 16-232-05 115 mm x 60 mm

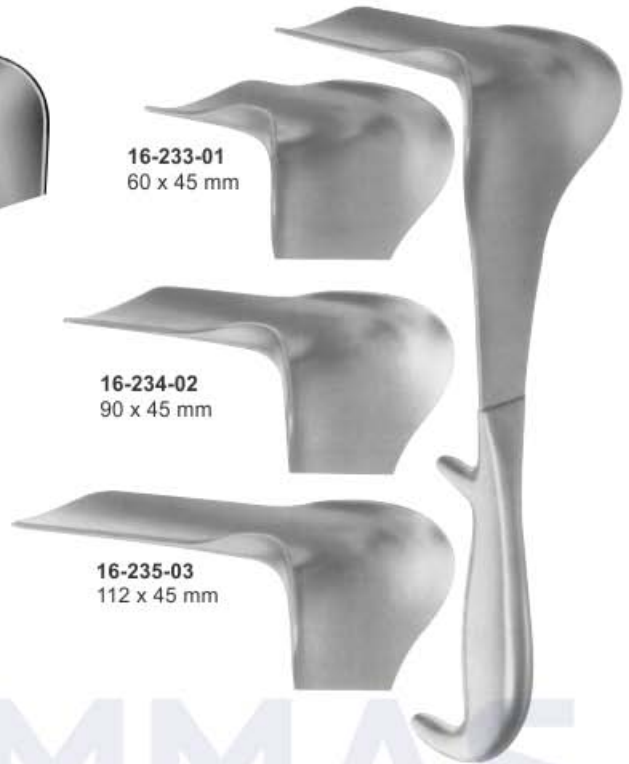

16-233-01  
60 x 45 mm

16-234-02  
90 x 45 mm

16-235-03  
112 x 45 mm

**DOYEN**  
Speculum & Retractor  
23.5 cm

KUMMAS CORPORATION



Veronikis Vaginal  
Retractors  
**16-236-01**  
30cm  
(2.5 cm) blade width



Veronikis Vaginal  
Retractors  
**16-237-02**  
(2.5 cm) blade width,  
34 cm length



Veronikis Vaginal  
Retractors  
**16-238-03**  
(3.8 cm) blade width,  
30cm. length



Veronikis Vaginal  
Retractors  
**16-239-04**  
(2.5 cm) Tapered blade,  
30cm. length



## VAGINAL RETRACTORS

Vaginal-Reraktoren | Retractores vaginales  
Rétracteurs vaginaux | Retrattori vaginali



56 x 13 mm

60 x 10 mm

**BRAUN**  
16-240-01  
18 cm

**BRAUN**  
16-241-01  
18 cm

**16-242-01**  
Handle with cold light  
carrier for upper blades  
28 cm

Vaginal Retractor

**Eastman**  
16-243-01 75X38mm  
16-244-02 90X38mm  
16-245-03 100X38mm

**16-246-01**  
115 x 22 mm  
**16-247-02**  
115 x 26 mm

**SIMON**  
115 x 22 mm  
27.5 cm

**DOYEN**  
16-248-01  
60x30mm  
lateral speculum  
23cm

**DOYEN**  
16-249-01  
80x30mm  
lateral speculum  
25cm

**WERTHEIM**  
Retractor  
16-250-01  
27.5cm  
3cm x 9.5cm

## VAGINAL RETRACTORS

Vaginal-Reraktoren | Retractores vaginales  
Rétracteurs vaginaux | Retrattori vaginali



### DOYEN RETRACTOR

26cm

16-251-01 40 x 80mm  
16-252-02 50 x 85mm  
16-253-03 53 x 80mm  
16-254-04 82 x 80mm



### Abdominal Retractor

16-255-01 48x90mm  
16-256-02 48x105mm  
16-257-03 48x120mm  
16-258-04 48x135mm



### Martin Vaginal Retractor

105x27mm

16-259-01 25 cm



### LANDON VAGINAL RETRACTOR

16-260-01

90x25mm  
22cm



### Heaney Hysterectomy Retractor

16-261-11 Fig.1 - 45x25mm  
16-262-12 Fig.2 - 65x28mm  
16-263-13 Fig.3 - 82x28mm  
19cm



16-264-16

16cm

16-265-19

19cm

**GELPI**  
Vulva Self Retaining



16-266-15

15.5cm

**COMYN BERKELEY**  
Vulva Self Retaining



**Landau Speculum**  
29 cm

**16-267-01** 100 mm x 28 mm  
**16-268-02** 100 mm x 38 mm  
semi concave

**Breisky Speculum**  
30 cm

**16-269-01** 130 mm x 20 mm  
**16-270-02** 130 mm x 25 mm  
**16-271-03** 130 mm x 30 mm  
**16-272-04** 130 mm x 35 mm  
**16-273-05** 130 mm x 40 mm  
Vienna pattern

**Breisky Speculum**  
30 cm

**16-274-01** 100 mm x 20 mm  
**16-275-02** 100 mm x 25 mm  
**16-276-03** 100 mm x 30 mm  
**16-277-04** 100 mm x 35 mm  
**16-278-05** 100 mm x 40 mm  
vienna pattern

**Breisky Speculum**  
35 cm

**16-279-01** 160 mm x 40 mm  
**16-280-02** 180 mm x 40 mm  
vienna pattern

## VAGINAL SPECULA

<i>Scheidenspekula</i>	<i>Espéculos vaginales</i>
<i>Spéculums vaginaux</i>	<i>Specoli vaginali</i>



**Garrigue Weighted Vaginal Speculum**  
16-281-01 4.0 cm x 8.0 cm  
Weight 2 lbs



**Henrotin Weighted Vaginal Speculum**  
16-282-01 3.8 cm x 9.0 cm  
Weight 3 lbs.



**AUVARD,**  
speculum & retractor  
16-283-01  
80 x 38 mm - 28 mm  
1,530 kg  
with fixed weight  
23 cm



**AUVARD**  
16-284-01  
65 x 38 mm - 28 mm  
1,530 kg  
with fixed weight  
23 cm



## VAGINAL SPECULA

Scheidenspekula | Espéculos vaginales  
Spéculum vaginaux | Specoli vaginali

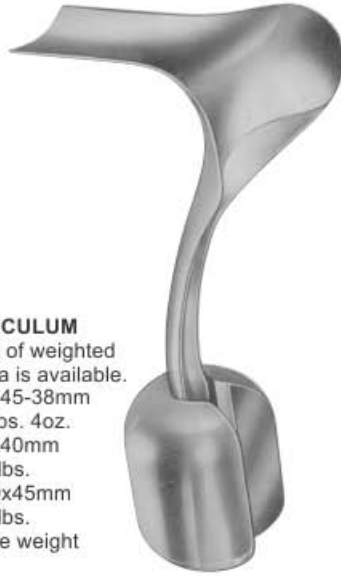

**AUVARD SPECULUM**  
An assortment of weighted Auvard specula is available.  
**16-285-01** 75x45-38mm  
1.470kg=3lbs. 4oz.  
**16-286-02** 85x40mm  
1.100 kgs=2.5lbs.  
**16-287-03** 100x45mm  
1.100 kgs=2.5lbs.  
with detachable weight  
230mm

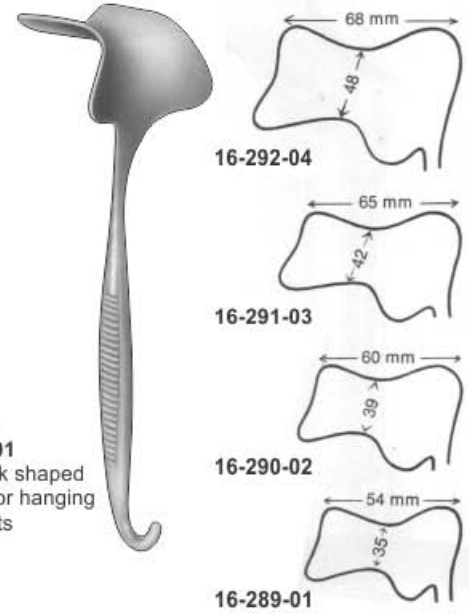

**MARTIN**  
**16-288-01**  
with hook shaped  
handle for hanging  
in weights  
27 cm



**STEINER SPECULUM**  
Ideal for deep vaginal surgery.  
Blades may be ordered from  
4" to 7", 5.5" is normal length.

**16-293-01**  
1.1 Kg / 2.5 lb;  
14 cm x 3 cm



**HARDY-DUDDY SPECULUM**  
It will not fall out. Design places the 3.5 lbs  
weight at a right angle to the shaft of the  
speculum, preventing expulsion. Many  
blade options are available.

**16-294-01**  
**Hardy-Duddy Speculum,**  
3.5 lbs., 120 mm x 35 mm  
cupped blade



**WEISSBARTH**  
speculum & retractor  
**16-295-01** 80 x 28 mm  
**16-296-02** 85 x 42 mm  
21 cm



**16-297-01**  
**Nichols Vaginal**  
Weighted Speculum  
with Suction, 2.5 lbs.  
7cm x 3.8cm

## VAGINAL SPECULA

Scheidenspekula | Espéculos vaginales  
Spéculum vaginaux | Specoli vaginali



**Scherback Speculum**  
**16-298-00**  
Set consisting of:  
handle weight 5 blades

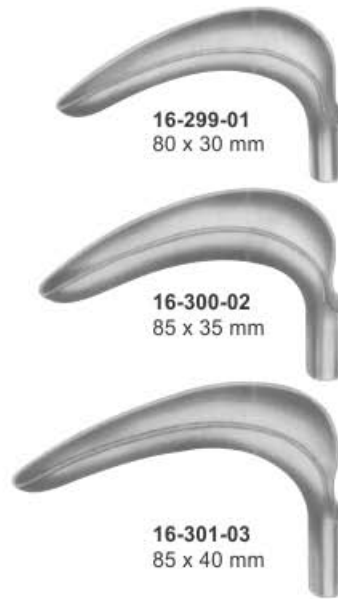

**Bozeman Speculum**  
**16-313-00**  
Handle Fig. 1

**Bozeman Speculum**  
**16-314-00**  
Handle Fig. 2

**Bozeman Speculum**  
**16-304-00**  
Set consisting of:  
2 handle, 8 blades

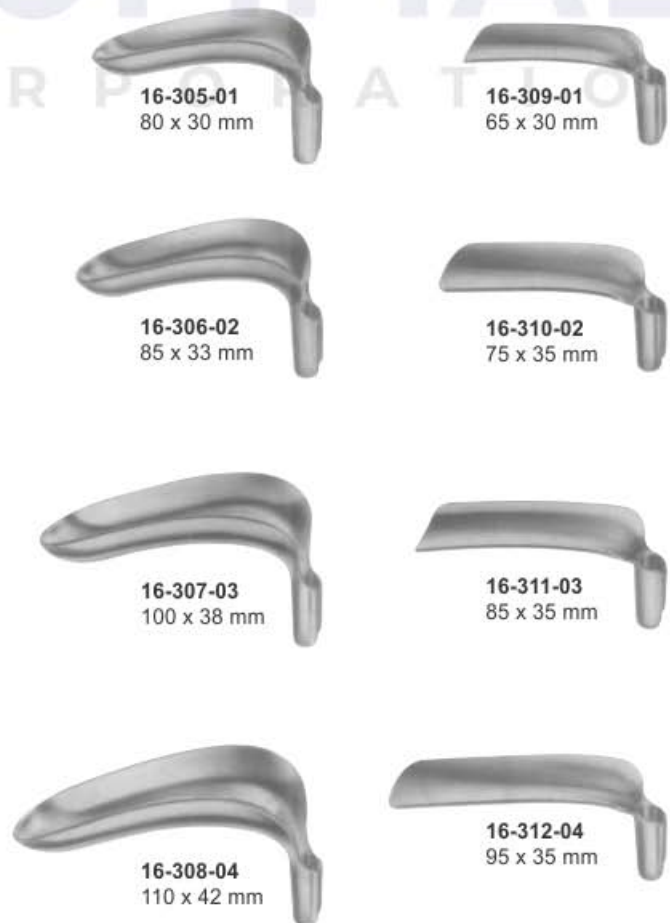



**Friedmann Retractor**  
16-315-10  
10 cm



**JOLL Thyroid Self Retaining**  
16-316-15 15.5cm



**O'Sullivan - O'Connor  
Vaginal Retractor**  
16-317-00 Set of 3 Complete



**16-318-01**  
45 x 17 mm



**16-319-02**  
90 x 37 mm



**16-320-03**  
90 x 45 mm

# UTERINE DILATORS

Uterusdilatoren | dilatadores uterinos  
 Dilatateurs utérins | Dilatatori uterini



**Hank Uterine Dilators 6 Set**  
**16-321-00** Complete Set  
 Curved, Delicate, Fig. 1 to 6  
 4.5mm to 10mm

**Hank Uterine Dilators,**  
 27cm  
 Double-ended

Fig.	mm Ø
16-322-01	9/10 4.5/5
16-323-02	11/12 5.5/6
16-324-03	13/14 6.5/7
16-325-04	15/16 7.5/8
16-326-05	17/18 8.5/9
16-327-06	19/20 9.5/10



**Bonney-Barker Dilators**  
**16-328-00** Set of 16 Pcs

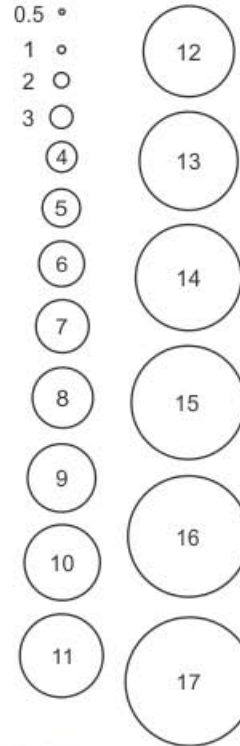

16-329-01	18.5cm 3-4-5mm
16-330-02	18.5cm 4-5-6mm
16-331-03	18.5cm 5-6-7mm
16-332-04	18.5cm 6-7-8mm
16-333-05	18.5cm 7-8-9mm
16-334-06	18.5cm 8-9-10mm
16-335-07	18.5cm 9-10-11mm
16-336-08	18.5cm 10-11-12mm
16-337-09	18.5cm 11-12-13mm
16-338-10	18.5cm 12-13-14mm
16-339-11	18.5cm 13-14-15mm
16-340-12	18.5cm 14-15-16mm
16-341-13	18.5cm 15-16-17mm
16-342-14	18.5cm 16-17-18mm
16-343-15	18.5cm 17-18-19mm
16-344-16	18.5cm 18-19-20mm



**Pratt Uterine Dilators 8/Set**  
**16-345-00** Complete Set  
 Curved, Delicate, 13-15 Fr. to  
 41-43 Fr., Straight

**Pratt Uterine Dilators,**  
 29.5cm  
 Double-ended

Fig.	mm Ø
16-346-01	13/15 4 1/2 / 5
16-347-02	17/19 5 2/3 / 6 1/3
16-348-03	21/23 7 / 7 2/3
16-349-04	25/27 8 1/2 / 9
16-350-05	29/31 9 2/3 / 10 1/3
16-351-06	33/35 11 / 11 2/3
16-352-07	37/39 12 1/3 / 13
16-353-08	41/43 13 2/3 / 14 1/3



**Hawkin Ambler Dilators**  
**16-354-00**  
 Set of 16 Pcs

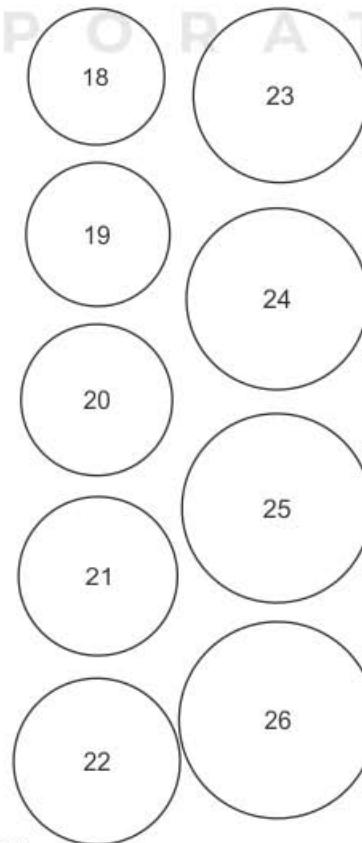

16-355-01	17cm 3-6mm
16-356-02	17cm 4-7mm
16-357-03	17cm 5-8mm
16-358-04	17cm 6-9mm
16-359-05	17cm 7-10mm
16-360-06	17cm 8-11mm
16-361-07	17cm 9-12mm
16-362-08	17cm 10-13mm
16-363-09	17cm 11-14mm
16-364-10	17cm 12-15mm
16-365-11	17cm 13-16mm
16-366-12	17cm 14-17mm
16-367-13	17cm 15-18mm
16-368-14	17cm 16-19mm
16-369-15	17cm 17-20mm
16-370-16	17cm 18-21mm





**Hegar uterine dilator**  
20cm  
double ended

16-371-01	0 / 1 mm Ø
16-372-02	1 / 2 mm Ø
16-373-03	3 / 4 mm Ø
16-374-04	5 / 6 mm Ø
16-375-05	7 / 8 mm Ø
16-376-06	9 / 10 mm Ø
16-377-07	11 / 12 mm Ø
16-378-08	13 / 14 mm Ø
16-379-09	15 / 16 mm Ø
16-380-10	17 / 18 mm Ø
16-381-11	19 / 20 mm Ø
16-382-12	21 / 22 mm Ø
16-383-13	23 / 24 mm Ø
16-384-14	25 / 26 mm Ø



**Hegar uterine dilator**  
16-385-00 3 / 4 mm - 17 / 18 mm Ø  
8 Pieces set  
16-386-00 1 / 2 mm - 25 / 26 mm Ø  
14 Pieces set



**Hegar Uterine Dilators**  
16-387-01  
8 Pieces set  
3/4mm to 17/18mm Ø



Hegar  
with siped handle

16-388-01	1mm Ø
16-389-02	2mm Ø
16-390-03	3mm Ø
16-391-04	4mm Ø
16-392-05	5mm Ø
16-393-06	6mm Ø
16-394-07	7mm Ø
16-395-08	8mm Ø
16-396-09	9mm Ø
16-397-10	10mm Ø
16-398-11	11mm Ø
16-399-12	12mm Ø
16-400-13	13mm Ø
16-401-14	14mm Ø
16-402-15	15mm Ø
16-403-16	16mm Ø
16-404-17	17mm Ø
16-405-18	18mm Ø
16-406-19	19mm Ø
16-407-20	20mm Ø
16-408-21	21mm Ø
16-409-22	22mm Ø
16-410-23	23mm Ø
16-411-24	24mm Ø
16-412-25	25mm Ø
16-413-26	26mm Ø
16-414-27	27mm Ø
16-415-28	28mm Ø
16-416-29	29mm Ø
16-417-30	30mm Ø

Set	mm	pieces per set
16-419-00	4-17	14
16-420-00	1-26	26



**Hegar Uterine Dilator**  
single ended  
16-418-01 4 mm - 17 mm Ø  
9 Pieces per set  
16-420-01 1 mm - 26 mm Ø  
26 Pieces per set



**Hegar Uterine Dilator**  
single ended  
16-419-01 4 mm - 17 mm Ø  
24 pieces per set

## VAGINAL RETRACTORS

Vaginal-Reraktoren | Retractores vaginales  
Rétracteurs vaginaux | Retrattori vaginali

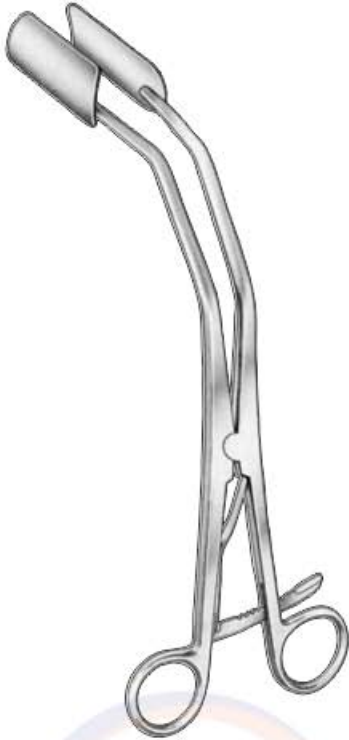

**NEW PORT**  
16-421-25  
25 cm

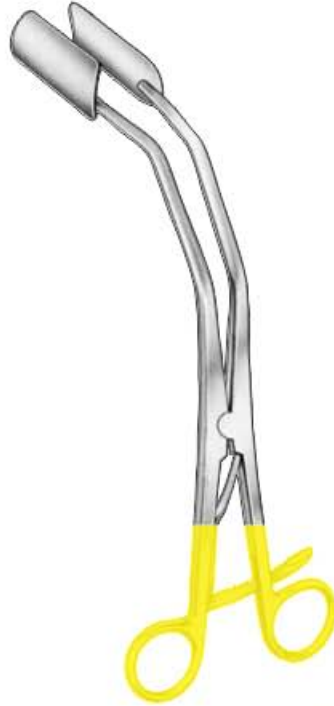

**Lateral Vaginal  
Retractor**  
16-422-21  
21 cm

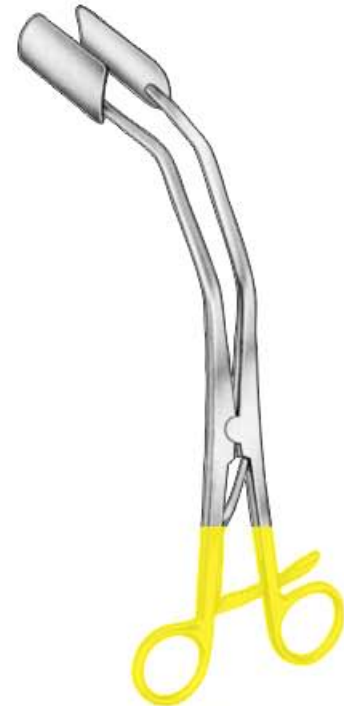

**Lateral Vaginal Retractor  
Blue Coated Leep / Lietz**  
16-423-21 21 cm

**KUMMAS**  
CORPORATION



**Side Wall Retractors**  
16-424-01 4-Sided Pederson Speculum, Medium  
16-425-02 4-Sided Pederson Speculum, Large  
Redundant Wall Retractor, 3.5 in. x .75 in. blades  
Lateral Wall Retractor, Closed Shanks, 2.25 in. blades  
Lateral Wall Retractor, Open Shanks, 2.5 in. blades



**Lateral Vaginal Retractor**  
Blue Coated  
16-426-26 26cm



**McGee Lateral  
Vaginal Retractor**  
With Ratchet Handle  
16-427-20 20cm

Vaginaler Spekulum-Rohrhaken, I.U.D-Instrumente

Gancho para tubo de espéculo vaginal, instrumentos para DIU

Crochet pour tube de spéculum vaginal, instruments I.U.D

Gancio per tubo speculum vaginale, strumenti I.U.D



**Kogan Speculum**  
16-428-24 24 cm  
with scale-ratchet  
and fixation screw



**Kogan Speculum**  
16-429-24 24 cm



**Kogan - Modif. Speculum**  
28 cm  
16-430-01  
x=4 mm y=8mm  
16-431-02  
x=2 mm y=4mm



**Kogan Endocervical Spatula**  
28cm  
16-432-01 Ratchet, Standard Tips  
16-433-02 Ratchet, Narrow Tips  
16-434-03 Set Screw, Standard Tips  
16-435-04 Set Screw, Narrow Tips



**RAMATHIBODI**  
16-436-27  
27.5 cm  
Uterine Manipulator



**RAMATHIBODI**  
16-437-25  
25 cm  
Tubal hook



**IUD Remover**  
16-438-01



**IUD String Retriever Hook**  
16-439-33  
33cm



**I.U.D Removing Forceps**  
16-440-23  
4 mm Ø 23cm

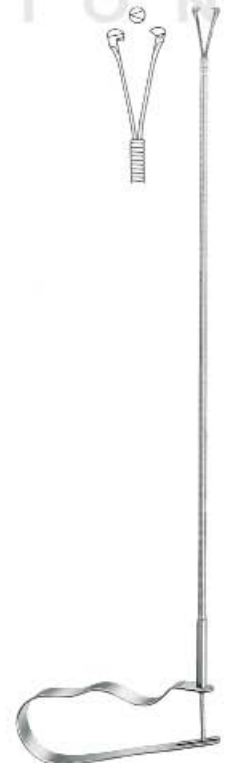

**IUP Grasping Forceps 3 mm**  
16-441-22 22 cm



## UTERINE SOUNDS

Uterus-Sonden

Histerómetros uterinos

Hystéromètres du col de l'utérus

Isterometri uterini



**Sims Uterine Sound**  
16-442-32  
32.5cm  
Non-graduated



**Sims Uterine Sound**  
16-443-33  
33 cm  
malleable



**Sims Uterine Sound**  
16-444-32  
32.5cm  
Graduated in cm



**Sims Uterine Sound**  
16-445-33  
33 cm  
copper silver-plated  
malleable



**Sims Uterine Sound**  
16-446-33  
33 cm  
stainless steel



**Sims Uterine Sound**  
Swedish. Modell  
16-447-26  
26 cm



## UTERINE SOUNDS

*Uterus-Sonden*

*Histerómetros uterinos*

*Hystéromètres du col de l'utérus*

*Isterometri uterini*

3mm



**Martin Uterine Sound**  
16-448-30 30 cm  
malleable

4mm



**Valleix Uterine Sound**  
16-449-25 25 cm

5mm



**Mayo Uterine Sound**  
16-450-33 33 cm  
biesam malleable

4mm



**Simpson Uterine Sound**  
16-451-29 29 cm  
malleable silver-plated

4mm



**Simpson Uterine Sound**  
16-452-32 32.5cm  
Graduated in inches

## TENACULUM FORCEPS

*Hakenzangen*

*Pinzas para coger el cuello del útero*

*Pinces pour l'abaissement du col de l'utérus*

*Pinze per abbassare il collo dell'utero*



**Staude - Moore**  
Tenaculum Forceps  
16-453-17 17 cm



**Barrett**  
Tenaculum Forceps  
16-454-18 18 cm



**Duplay Tenaculum**  
Forceps  
16-455-28 28 cm



**Pozzi Tenaculum Forceps**  
16-456-25 25.5 cm



**Braun**  
Tenaculum Forceps Sharp  
16-457-25 25 cm



**Schroeder**  
Tenaculum Forceps  
16-458-25 25 cm  
sharp



**Skene**  
Tenaculum Forceps  
16-459-24 24 cm



**Iowa Tenaculum**  
Forceps  
16-460-26 26 cm



**Beacham**  
Amniotome  
16-461-26 26 cm



**16-463-21**  
21 cm  
Curved

**Jacobs Uterine Vulsellum Forceps**

2x2 teeth  
**16-462-21** 21 cm  
 Straight

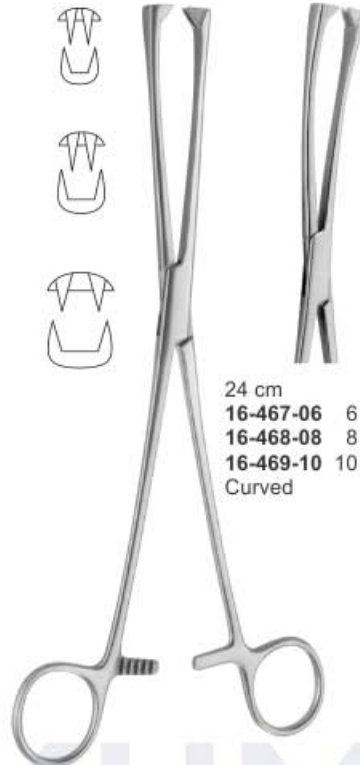

24 cm  
**16-467-06** 6 mm  
**16-468-08** 8 mm  
**16-469-10** 10 mm  
 Curved

**Museux Vulsellum Forceps**

2x2 teeth  
**16-464-06** 6 mm  
**16-465-08** 8 mm  
**16-466-10** 10 mm  
 24 cm Straight

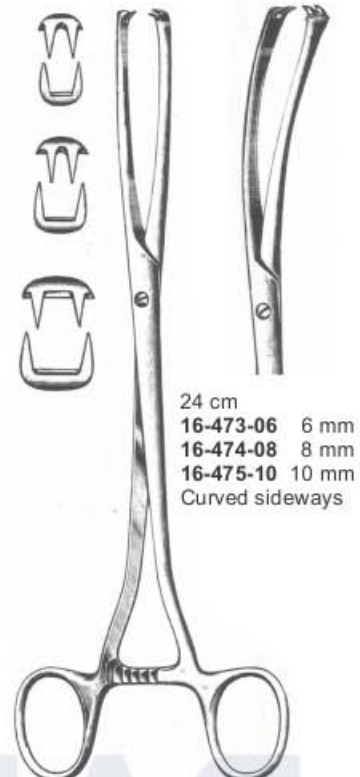

24 cm  
**16-473-06** 6 mm  
**16-474-08** 8 mm  
**16-475-10** 10 mm  
 Curved sideways

**Museux Vulsellum Forceps**

2x2 teeth  
**16-470-06** 6 mm  
**16-471-08** 8 mm  
**16-472-10** 10 mm  
 24cm Curved sideways

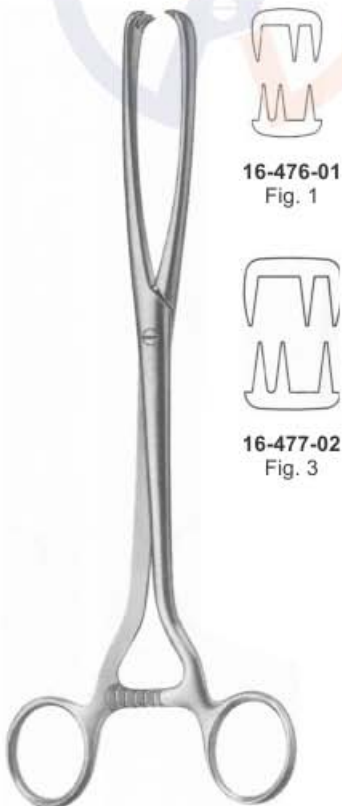

**16-476-01**  
Fig. 1

**16-477-02**  
Fig. 3

**Museux Vulsellum Forceps**

26.5cm  
 3x3 teeth



**Teale Tenaculum Forceps**

**16-478-24**  
24 cm Straight  
**16-479-24**  
24 cm Curved



**Pratt Tenaculum Forceps**  
**16-480-26** 26 cm



**Czerny Tenaculum Forceps**  
**16-481-20** 20.5 cm

## TENACULUM FORCEPS

Hakenzangen

Pinzas para coger el cuello del útero

Pinces pour l'abaissement du col de l'utérus

Pinze per abbassare il collo dell'utero



16-482-24  
24 cm

16-483-24  
24 cm

Schroeder Vulsellum  
Tenaculum Forceps

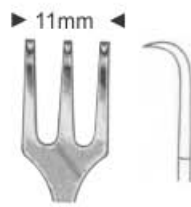

11mm



SCHRÖDER  
16-484-27  
27cm

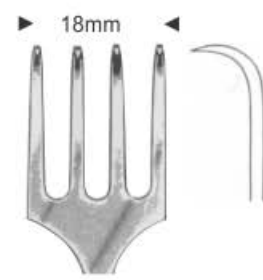

18mm



PRATT  
16-485-26  
26cm



9mm

MUSEUX  
16-486-20  
20cm



9mm



LAHEY  
16-487-15  
15.5cm



9mm



LAHEY  
16-488-15  
15.5cm



10mm



BRAUN  
16-489-15  
15.5cm



## POLYPUS-AND OVUM FORCEPS

Polypen- und Eizange

Fórceps para óvulos y pólipos

Pince à polypes et ovules

Tenaculum e Vulsellum Forceps



**COLLIN**  
**16-490-25**  
25cm



**COLLIN**  
**16-491-28**  
28.5cm



**DARTIGUES**  
**16-492-25**  
25.5cm



**HEYWOOD-SMITH**  
**16-493-25**  
25cm



**HEYWOOD-SMITH**  
**16-494-25**  
25cm



**KELLY**  
**16-495-32**  
32cm

Abortuszangen - Abortusküretten

Pinzas para abort - Curetas para aborto

Pinces à faux germes - Curette d'avortement

Pinze per placenta ed aborto - Curette per placenta ed aborto

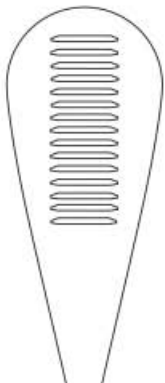

**Cuzzi**



14.5 mm  
16-496-14  
30 cm



18 mm  
16-497-18  
30 cm



21 mm  
16-498-21  
30 cm



**Wallich**  
ovum curette  
16-499-42 42cm

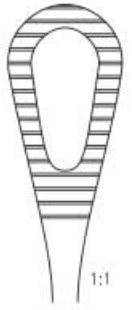

**Pestaloza**  
Ovum Curette  
16-500-30 30cm

**Cuzzi**  
ovum curette  
blunt, back serrated



Fig. 1 Fig. 2 Fig. 3

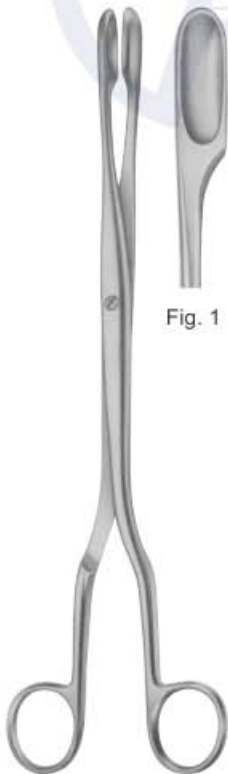

Fig.1 Fig.2 Fig.3



16-507-27  
27 cm  
Straight

16-508-27  
27 cm  
Curved



**WINTER**  
Placenta and Ovum Forceps  
16-501-01 Fig. 1  
16-502-02 Fig. 2  
16-503-03 Fig. 3  
29 cm

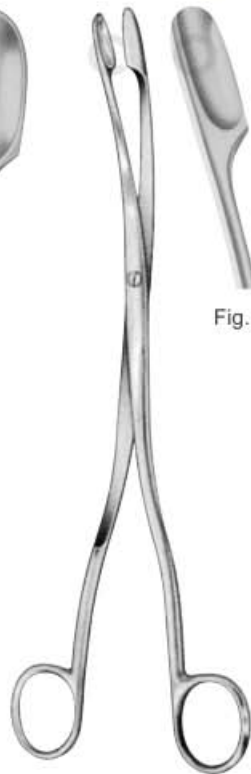

**WINTER**  
Placenta and Ovum Forceps  
16-504-01 Fig. 1  
16-505-02 Fig. 2  
16-506-03 Fig. 3  
29 cm

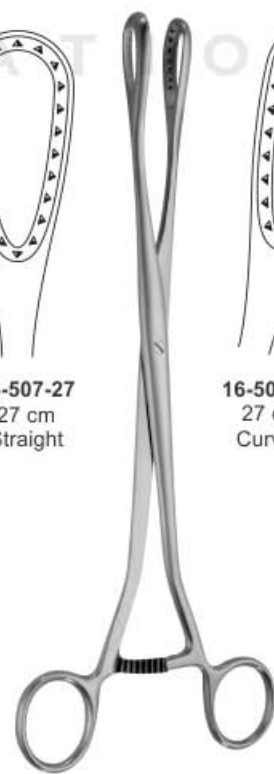

**Saenger**  
Placenta and Ovum Forceps

## HYSTERECTOMY FORCEPS

Hysterektomiezange | fórceps de histerectomía  
Pince à hystérectomie | Pinza per isterectomia



**16-509-20**  
20 cm  
1 x 2th, Angled  
Screw Joint

**BONNEY**



**16-510-20**  
20 cm  
1 x 2th, Curved  
Screw Joint

**BONNEY-BERKLEY**

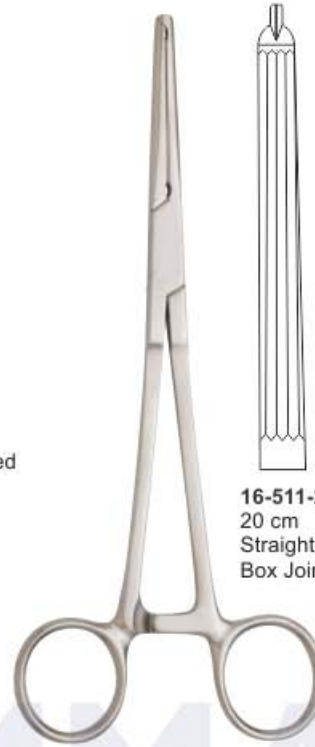

**16-511-20**  
20 cm  
Straight  
Box Joint

**16-512-20**  
20 cm  
Curved  
Box Joint

**GWILLIAM**



**16-513-20**    **16-514-20**  
20 cm            20 cm  
Curved            Curved  
1 tooth            2 Teeth  
Box Joint        Box Joint

**HEANEY**



**16-515-23**  
23 cm  
Curved  
Box Joint

**HUNTER**



**16-516-20**  
20 cm  
Straight  
Box Joint

**16-517-20**  
20 cm  
Curved  
Box Joint

**MAINGOT**

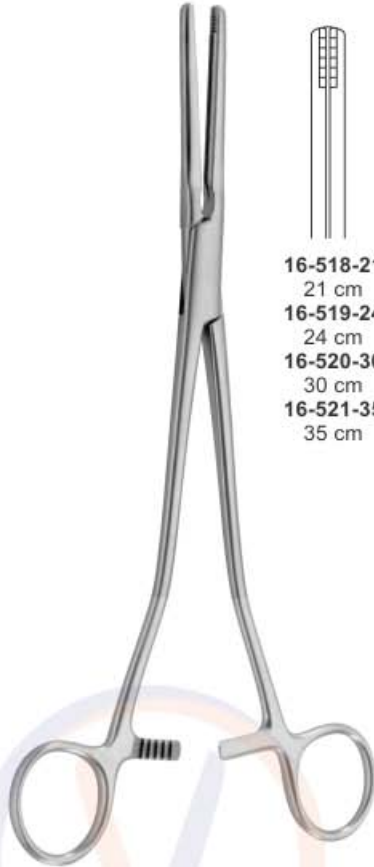

**Parametrium  
Hysterectomy  
Forceps**

**16-518-21**  
21 cm  
**16-519-24**  
24 cm  
**16-520-30**  
30 cm  
**16-521-35**  
35 cm

**16-522-21**  
21 cm  
**16-523-24**  
24 cm  
**16-524-30**  
30 cm  
**16-525-35**  
35 cm

**16-526-21**  
21 cm  
**16-527-24**  
24 cm  
**16-528-30**  
30 cm  
**16-529-35**  
35 cm

**16-530-21**  
21 cm  
**16-531-24**  
24 cm  
**16-532-30**  
30 cm  
**16-533-35**  
35 cm

**16-534-21**  
21 cm  
**16-535-24**  
24 cm  
**16-536-30**  
30 cm  
**16-537-35**  
35 cm  
S-curved



**Rogers Parametrium  
Hysterectomy Forceps**

**16-538-01**  
Fig. 1  
22 cm

**16-539-02**  
Fig. 2  
21.5 cm

**16-540-03**  
Fig. 3  
21 cm

**16-541-04**  
Fig. 4  
20.5 cm

**16-542-01**  
Fig. 1  
25 cm

**16-543-02**  
Fig. 2  
25 cm

**16-544-03**  
Fig. 3  
24.5 cm

**16-545-04**  
Fig. 4  
23 cm





**Schultze, Salpingograph**  
**16-546-00** 29.5 cm  
 complete in wooden case



**Gellhorn  
 Biopsy Forceps**  
**16-547-23** 23 cm



**Thoms-Gaylor  
 Biopsy Forceps**  
**16-548-24** 24 cm



**Gaylor**  
**16-549-24**  
 24cm



**Schubert Biopsy Forceps**  
16-550-21 21 cm  
16-551-28 28 cm

**Schubert**  
16-552-21  
21cm

**Schubert**  
Biopsy Forceps  
16-553-21 21cm

**Faure Uterine**  
Biopsy Forceps  
16-554-21 21cm

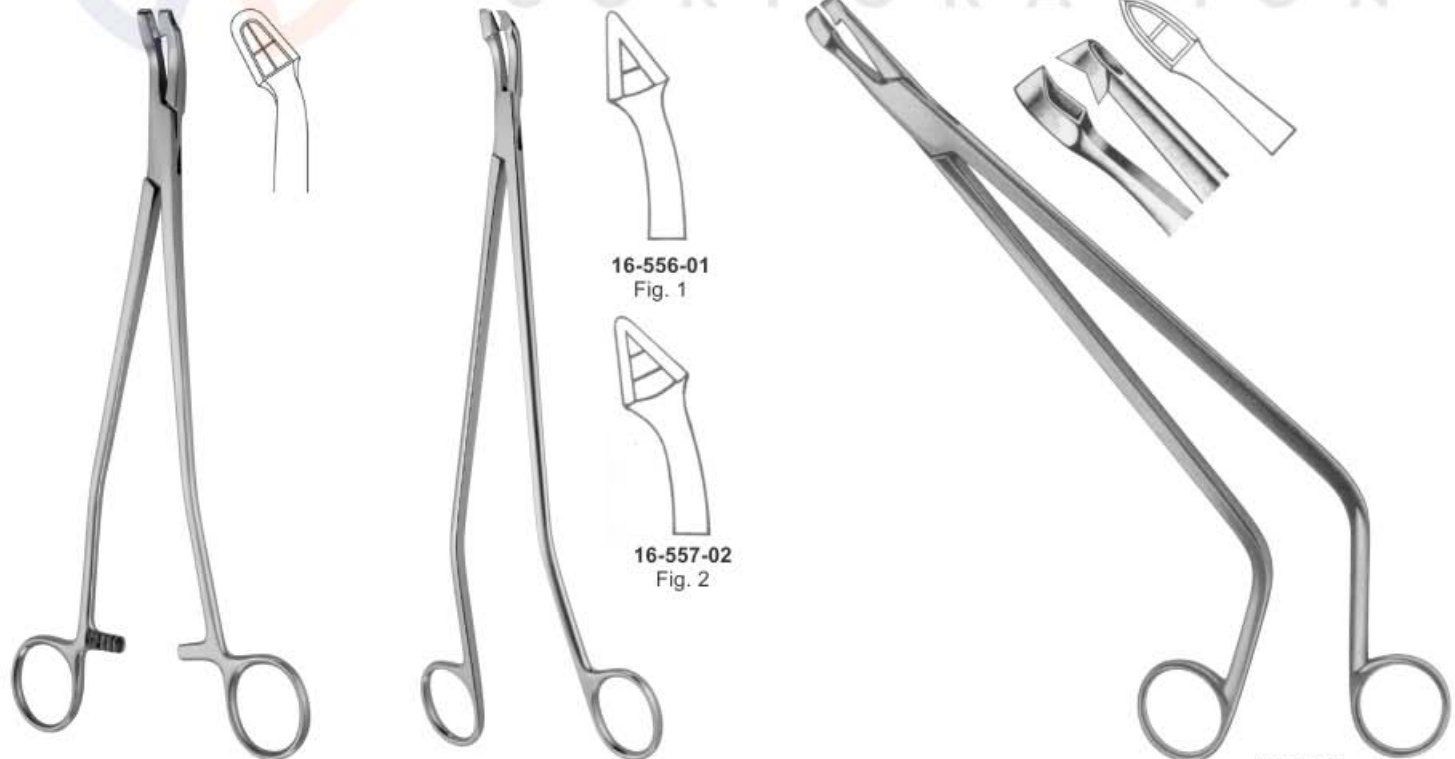

**Van Doren**  
Biopsy Forceps  
16-555-24 24cm

**Schumacher**  
Biopsy Forceps  
24cm

**Tischler**  
16-558-27  
27cm

16-556-01  
Fig. 1

16-557-02  
Fig. 2



**Burke Biopsy Forceps**  
16-559-21  
21.5cm Shaft

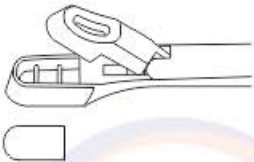

**Eppendorf Biopsy Forceps**  
16-560-20  
20cm Shaft



**Kevorkian Young Biopsy Forceps**  
16-561-25  
25.5cm Shaft



**Leechwilkinson Biopsy Forceps**  
16-562-20  
20cm Shaft Round



Probeexzisionszangen

Pinzas saca-bocados para biopsia

Pinces emporte-pièces à biopsie

Pinze taglianti per biopsia



**Schumacher Biopsy Forceps**  
16-563-01  
Small Jaw 24cm Shaft

**Schumacher Biopsy Forceps**  
16-564-02  
Large Jaw 24cm Shaft



**Wittner Biopsy Forceps**  
16-565-01 23cm  
Shaft Straight

**Wittner Biopsy Forceps**  
16-566-02 23cm  
Shaft Angled



**Tischler Baby Biopsy Forceps**  
16-567-21  
21.5cm Shaft



**Tischler Biopsy Forceps**  
16-568-21  
21.5cm Shaft





**Tischler - Morgan**  
Biopsy and Specimen  
Forceps  
USA Modell  
**16-569-01**  
x = 200 mm  
**16-570-02**  
x = 250 mm

**Tischler - Morgan**  
Biopsy and Specimen  
Forceps  
**16-571-01**  
x = 200 mm  
**16-572-02**  
x = 250 mm

Instruments as illustrated,  
but without locking screw.



**Mini - Tischler**  
Biopsy and Specimen  
Forceps  
**16-573-01**  
x = 200 mm  
**16-574-02**  
x = 250 mm

**Mini - Tischler**  
Biopsy and Specimen  
Forceps  
**16-575-01**  
x = 200 mm  
**16-576-02**  
x = 250 mm

Instruments as illustrated,  
but without locking screw.

KUMMAS  
CORPORATION



**Schumacher**  
Biopsy and Specimen Forceps  
**16-577-01**      **16-578-02**  
x = 23 cm      x = 23 cm  
complete      tip



**Uni - Tischler**  
Biopsy and  
Specimen Forceps  
**16-580-01**  
3 x 7 mm  
Straight, Tip only



**Uni - Tischler**  
Biopsy and  
Specimen Forceps  
**16-581-02**  
3 x 7 mm  
up, Tip only



**Uni - Tischler**  
Biopsy and  
Specimen Forceps  
**16-582-03**  
3 x 7 mm  
down, Tip only



**Biopsy and Specimen  
Forceps Handle only**  
**16-579-00**



**Uni - Townsend**  
Biopsy and  
Specimen Forceps  
**16-583-04**  
2.3 x 4 mm  
straight, Tip only



**Uni - Townsend**  
Biopsy and  
Specimen Forceps  
**16-584-05**  
2.3 x 4 mm  
up, Tip only



**Uni - Townsend**  
Biopsy and  
Specimen Forceps  
**16-585-06**  
2.3 x 4 mm  
down, Tip only



**Uni - Kevorkian**  
Biopsy and  
Specimen Forceps  
**16-586-07**  
3 x 9 mm  
Tip only



**Uni - Oval**  
Biopsy and  
Specimen Forceps  
**16-587-08**  
3 x 5 mm  
Tip only



**Uni - Burke**  
Biopsy and  
Specimen Forceps  
**16-588-09**  
3 x 5 mm  
Tip only



**Uni - Tischler**  
Biopsy and  
Specimen Forceps  
**16-590-01**  
3 x 7 mm  
Straight, Tip only



**Uni - Tischler**  
Biopsy and  
Specimen Forceps  
**16-591-02**  
3 x 7 mm  
up, Tip only



**Uni - Tischler**  
Biopsy and  
Specimen Forceps  
**16-592-03**  
3 x 7 mm  
down, Tip only

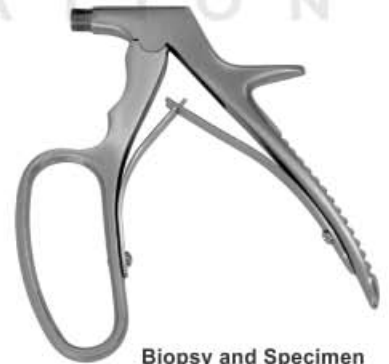

**Biopsy and Specimen  
Forceps Handle only**  
**16-589-00**



**Uni - Townsend**  
Biopsy and  
Specimen Forceps  
**16-593-04**  
2.3 x 4 mm  
straight, Tip only



**Uni - Townsend**  
Biopsy and  
Specimen Forceps  
**16-594-05**  
2.3 x 4 mm  
up, Tip only



**Uni - Townsend**  
Biopsy and  
Specimen Forceps  
**16-595-06**  
2.3 x 4 mm  
down, Tip only

**Uni - Kevorkian**  
Biopsy and  
Specimen Forceps  
**16-596-07**  
3 x 9 mm  
Tip only



**Uni - Oval**  
Biopsy and  
Specimen Forceps  
**16-597-08**  
3 x 5 mm  
Tip only



**Uni - Burke**  
Biopsy and  
Specimen Forceps  
**16-598-09**  
3 x 5 mm  
Tip only

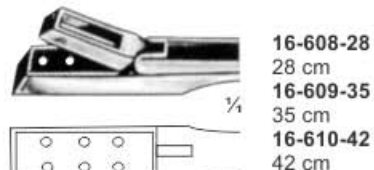
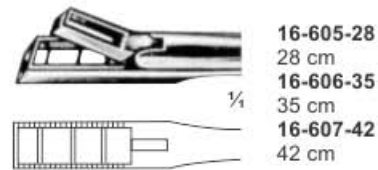
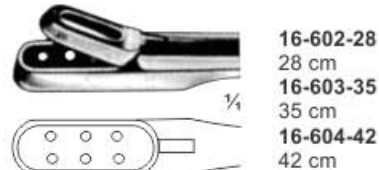
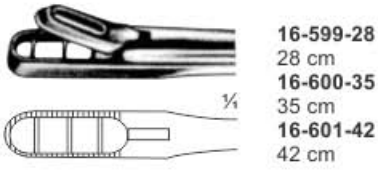
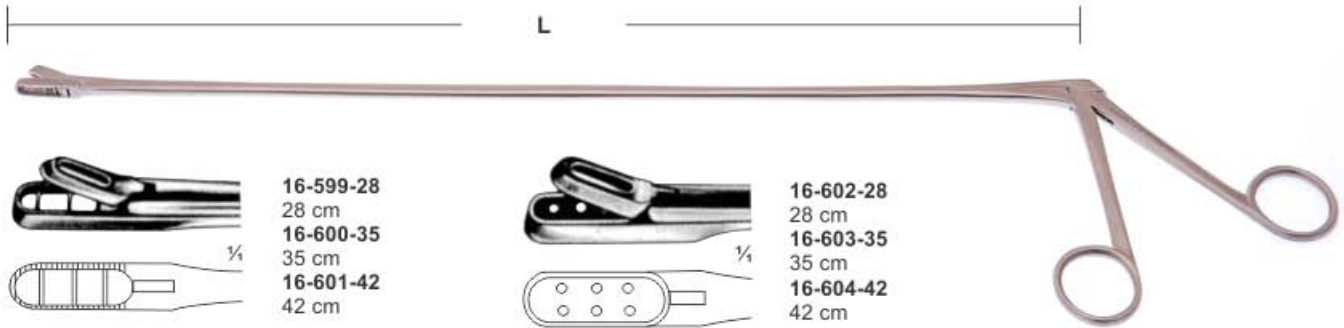

YEOMANN

**KUMMAS CORPORATION**

PILE FORCEPS

COTTON CARRIER

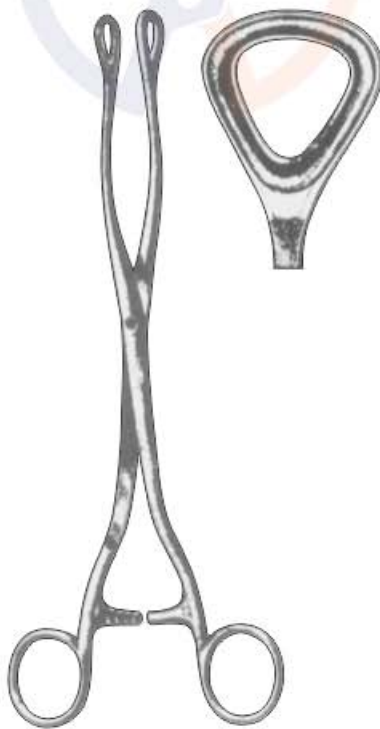

**LURE**  
**16-611-24**  
 24.5cm



**JARVIS**  
**16-612-23**  
 23cm



**LANGENBECK**  
**16-613-45**  
 45cm



**16-614-45**  
 45cm



5mm  
 1/4  
**16-615-01** 5mm x 25mm  
 11.5cm  
**16-616-02** 5mm x 50mm  
 14cm  
**16-617-03** 5mm x 80mm  
 17cm  
 Cannula

**HORMONE**  
 Implant Trocar Set



6EG 4mm  
 7EG 4.5mm  
 8EG 5mm  
 9EG 5.5mm  
 10EG 6mm  
**16-618-06** 6EG S/P  
**16-619-07** 7EG S/P  
**16-620-08** 8EG S/P  
**16-621-09** 9EG S/P  
**16-622-10** 10EG S/P  
 15.5 cm

**FEMALE**  
 Catherers



8EG 5mm  
 10EG 6mm  
**16-623-08** 8EG S/P  
**16-624-10** 10EG S/P  
 19cm

**ROTUNDA**  
 Catherers



6EG 4mm  
 8EG 5mm  
 10EG 6mm  
 12EG 7mm  
**16-625-01** 6EG S/P  
**16-626-02** 8EG S/P  
**16-627-03** 10EG S/P  
**16-628-04** 12EG S/P  
 24cm

**FEMALE**  
 Bladder Sounds  
**16-625-01** 6EG S/P  
**16-626-02** 8EG S/P  
**16-627-03** 10EG S/P  
**16-628-04** 12EG S/P  
 24cm

**NEEDLE EXTENSIONS**



**LEUR**  
 Needle Extensions  
**16-629-07** 7.5cm  
**16-630-10** 10cm  
**16-631-13** 13cm



**BONNEY**  
 Vaginal Clamps  
**16-632-34**  
 34.5cm  
 Screw Joint



**VAGINAL**  
 Dressing Forceps  
**16-633-24**  
 24cm  
 Serrated





**Segond Myoma Knife Fistula Hook**  
16-634-27  
27 cm



**Ayre Cone Knife Fistula Hook**  
16-635-23  
23 cm

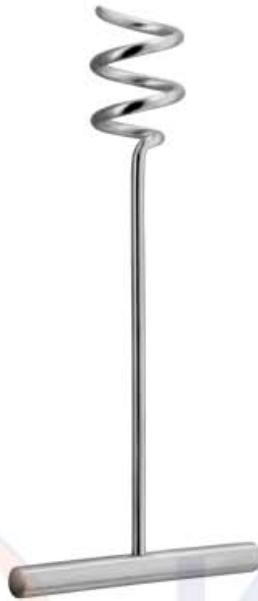

**Doyen Myoma Screw**  
16-636-14 14.5cm  
16-637-17 17 cm



Fig.1  
16-638-01  
22 cm

**Simon Fistula Hook One Prong**



Fig. 1  
16-639-01  
22 cm

**Simon Fistula Hook Two Prong**



**Emmet Fistula Hook**



Fig. 1  
16-640-01  
22 cm

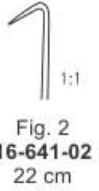

Fig. 2  
16-641-02  
22 cm

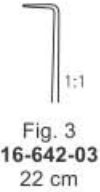

Fig. 3  
16-642-03  
22 cm

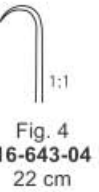

Fig. 4  
16-643-04  
22 cm



Fig. 5  
16-644-05  
22 cm



**SMELLIE**  
16-645-30  
30 cm



**Braun, Decapitating hook**  
16-646-32  
32.5 cm



**Suture Retrieval Hook**  
16-647-27  
27cm



**Suture Retrieval Hook Sims Handle**  
16-648-27  
27 cm



**IRIS Skin Hooks**



16-649-18  
18cm  
Fine  
Colour Coated



16-650-25  
25.5cm  
Fine  
Colour Coated



**TENACULUM EMETT**  
16-651-23  
23cm



**WHITTAKER**  
16-652-18  
18.5cm



**TENACULUM 3 PRONG**  
16-653-26  
26cm  
\*bic\*

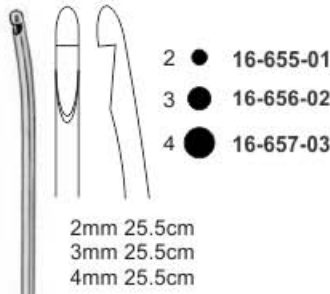

**Uni - Randall**  
aspirating curette  
**16-654-24**  
24 cm

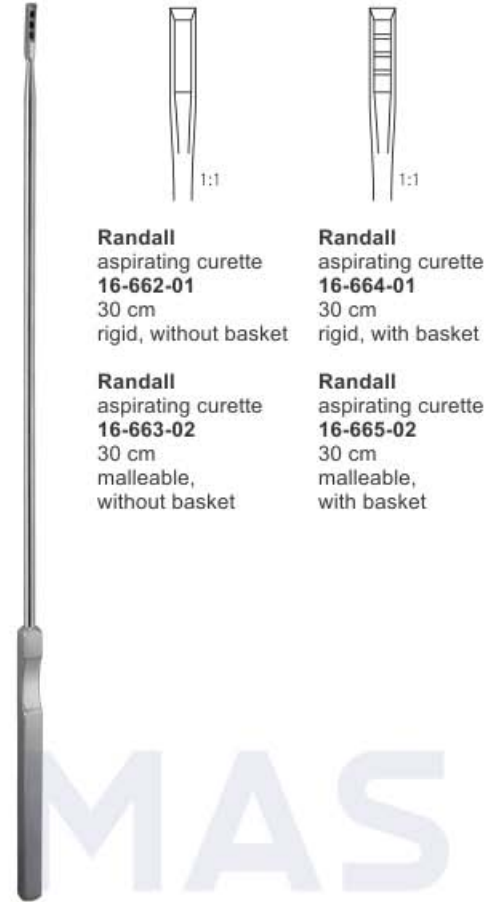

**Specimen And Aspirating Curette**

- 20 cm  
**16-667-03** 3 mm Ø  
**16-668-04** 4 mm Ø  
**16-669-06** 6 mm Ø  
**16-670-08** 8 mm Ø  
**16-671-10** 10 mm Ø  
**16-672-12** 12 mm Ø  
**16-673-14** 14 mm Ø

**Coupling Piece**  
aspirating curette  
12 cm  
**16-666-00**

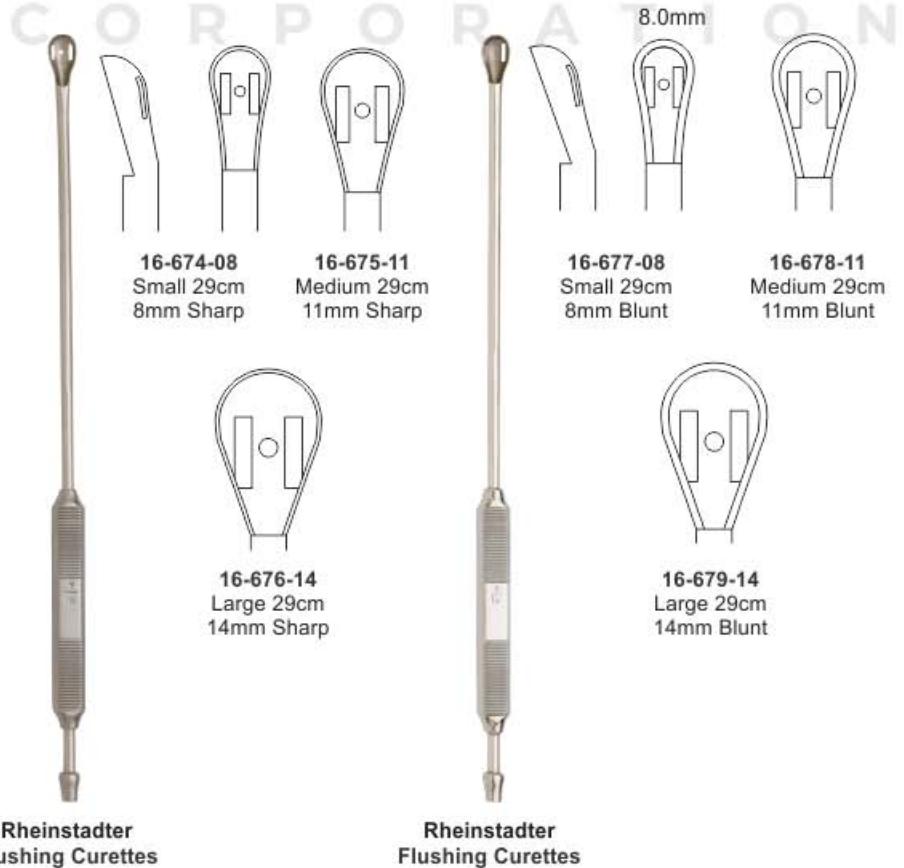

## FLUSHING CURETTES

Küretten spülen

Curetas de lavado

Curettes de rinçage

Curette di lavaggio



**Leechwilkinson  
Suction Biopsy Curettes**

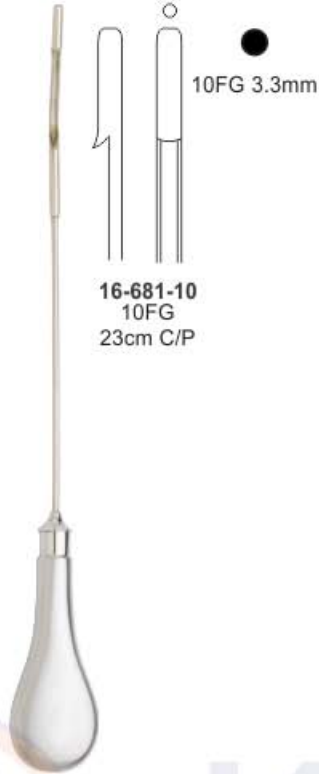

**Sharman Endometrial  
Biopsy Curettes**



**Kevorkian Endocervical  
Curettes  
With Basket Round  
30cm**



**Kevorkian Endocervical  
Curettes  
With Basket Square  
30cm**



**Kevorkian Endocervical  
Curettes  
Without Basket Square  
30cm**



**Braun Uterine Depressor  
16-685-28 28 cm**



**Blake Double Ended  
16-686-24 24.5 cm  
Sharp / Blunt**



**Blake  
16-687-27  
27 cm**



**Zweifel Double Ended  
16-688-24 24.5cm  
Sharp / Sharp**

## UTERINE CURETTES

<i>Uterusküretten</i>	<i>Curettes uterinas</i>
<i>Curettes utérines</i>	<i>Curette uterine</i>



**Sims**  
**Double Ended**  
Sharp/Sharp  
25.5cm

**16-689-01**  
Small 6mm X 5mm  
Sharp  
Sharp 25.5cm



**16-690-02**  
Medium  
9mm X 6mm Sharp  
Sharp 25.5cm



**16-691-03**  
Large  
12mm X 9mm Sharp  
Sharp 25.5cm



**Sims**  
**Double Ended**  
Sharp/Blunt

**16-692-01**  
Small  
6mm X 5mm



**16-693-02**  
Medium  
9mm X 6mm



**16-694-03**  
Large  
12mm X 9mm



**Sims**  
**Single Ended**  
25.5cm  
Sharp

**16-695-06**  
Small 6mm  
Sharp



**16-696-09**  
Medium 9mm  
Sharp



**16-697-12**  
Large 12mm  
Sharp



**Sims**  
**Single Ended**  
25.5cm  
Blunt

**16-698-06**  
Small 6mm  
Blunt



**16-699-09**  
Medium 9mm  
Blunt



**16-700-12**  
Large 12mm  
Blunt

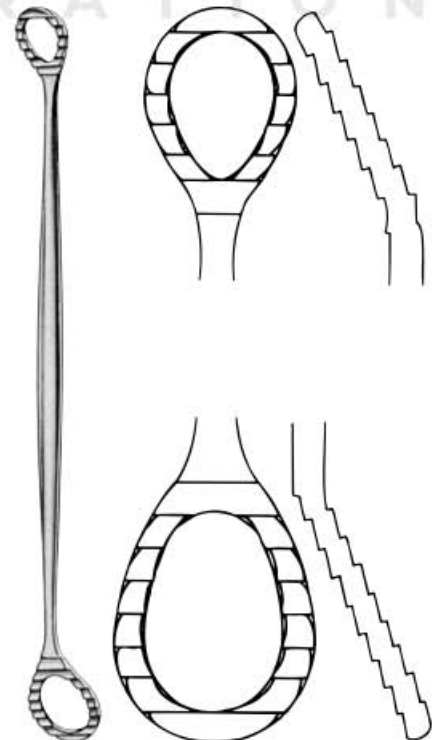

**Sims**  
**16-701-26**  
26 cm



# UTERINE CURETTES

Uterusküretten | Currettes uterinas  
Currettes utérines | Curette uterine



**Recamier**  
uterine curette  
26cm long

**Recamier**  
uterine curette  
31cm long

Fig.	Sharp, Malleable	Blunt, Malleable	Sharp Rigid	Sharp Blunt
00	16-702-01	16-716-01	16-730-01	16-744-01
0	16-703-02	16-717-02	16-731-02	16-745-02
1	16-704-03	16-718-03	16-732-03	16-746-03
2	16-705-04	16-719-04	16-733-04	16-747-04
3	16-706-05	16-720-05	16-734-05	16-748-05
4	16-707-06	16-721-06	16-735-06	16-749-06
5	16-708-07	16-722-07	16-736-07	16-750-07
6	16-709-08	16-723-08	16-737-08	16-751-08
7	16-710-09	16-724-09	16-738-09	16-752-09
8	16-711-10	16-725-10	16-739-10	16-753-10
9	16-712-11	16-726-11	16-740-11	16-754-11
10	16-713-12	16-727-12	16-741-12	16-755-12
11	16-714-13	16-728-13	16-742-13	16-756-13
12	16-715-14	16-729-14	16-743-14	16-757-14

Fig.	Sharp, Malleable	Blunt, Malleable	Sharp Rigid	Sharp Blunt
00	16-758-01	16-772-01	16-786-01	16-800-01
0	16-759-02	16-773-02	16-787-02	16-801-02
1	16-760-03	16-774-03	16-788-03	16-802-03
2	16-761-04	16-775-04	16-789-04	16-803-04
3	16-762-05	16-776-05	16-790-05	16-804-05
4	16-763-06	16-777-06	16-791-06	16-805-06
5	16-764-07	16-778-07	16-792-07	16-806-07
6	16-765-08	16-779-08	16-793-08	16-807-08
7	16-766-09	16-780-09	16-794-09	16-808-09
8	16-767-10	16-781-10	16-795-10	16-809-10
9	16-768-11	16-782-11	16-796-11	16-810-11
10	16-769-12	16-783-12	16-797-12	16-811-12
11	16-770-13	16-784-13	16-798-13	16-812-13
12	16-771-14	16-785-14	16-799-14	16-813-14

# UTERINE CURETTES

Uterusküretten | Currettes uterinas  
Currettes utérines | Curette uterine



**Recamier**  
uterine curette  
34 cm



Fig. 13  
25mm



Fig. 14  
30mm



Fig. 15  
35mm



Fig. 16  
40mm

Fig.  
13  
14  
15  
16

Sharp, Malleable  
**16-814-01**  
**16-815-02**  
**16-816-03**  
**16-817-04**

Blunt, Malleable  
**16-818-01**  
**16-819-02**  
**16-820-03**  
**16-821-04**

Sharp Rigid  
**16-822-01**  
**16-823-02**  
**16-824-03**  
**16-825-04**

Sharp Blunt  
**16-826-01**  
**16-827-02**  
**16-828-03**  
**16-829-04**

**KUMMAS**  
CORPORATION



**Sims**  
uterine curette  
26cm



Fig. 1



Fig. 2



Fig. 3



Fig. 4



Fig. 5



Fig. 6

Fig.  
1  
2  
3  
4  
5  
6

Sharp Blunt  
**16-830-01**  
**16-831-02**  
**16-832-03**  
**16-833-04**  
**16-834-05**  
**16-835-06**

Blunt, Malleable  
**16-836-01**  
**16-837-02**  
**16-838-03**  
**16-839-04**  
**16-840-05**  
**16-841-06**

Sharp Rigid  
**16-842-01**  
**16-843-02**  
**16-844-03**  
**16-845-04**  
**16-846-05**  
**16-847-06**

Sharp Blunt  
**16-848-01**  
**16-849-02**  
**16-850-03**  
**16-851-04**  
**16-852-05**  
**16-853-06**

# UTERINE CURETTES

Uterusküretten | Curettes uterinas  
Curettes utérines | Curette uterine



Fig. 0 - 10mm



Fig. 1 - 11mm



Fig. 2 - 13mm



Fig. 3 - 15mm



Fig. 4 - 17mm



**Bumm**  
Uterine Curette,  
sharp, malleable shaft,  
28 - 31cm long

- 16-854-10 fig. 0 - 10mm wide
- 16-855-11 fig. 1 - 11mm wide
- 16-856-12 fig. 2 - 13mm wide
- 16-857-15 fig. 3 - 15mm wide
- 16-858-17 fig. 4 - 17mm wide
- 16-859-19 fig. 5 - 19mm wide
- 16-860-21 fig. 6 - 21mm wide



Fig. 5 - 19mm



Fig. 6 - 21mm

**Bumm**  
Uterine Curette,  
blunt, malleable shaft,  
28 - 31cm long

- 16-861-10 fig. 0 - 10mm wide
- 16-862-11 fig. 1 - 11mm wide
- 16-863-13 fig. 2 - 13mm wide
- 16-864-15 fig. 3 - 15mm wide
- 16-865-17 fig. 4 - 17mm wide
- 16-866-19 fig. 5 - 19mm wide
- 16-867-21 fig. 6 - 21mm wide



16-868-10  
Fig. 1 - 10mm



16-869-11  
Fig. 2 - 11mm



16-870-12  
Fig. 3 - 12mm



16-874-10  
10mm



16-875-12  
12mm



16-871-13  
Fig. 4 - 13mm



16-872-14  
Fig. 5 - 14mm



16-873-15  
Fig. 6 - 15mm



16-876-14  
14mm

**Thomas**  
Uterine Curette,  
blunt, malleable shaft,  
28 cm

- 16-868-10 fig. 1 - 10mm wide
- 16-869-11 fig. 2 - 11mm wide
- 16-870-12 fig. 3 - 12mm wide
- 16-871-13 fig. 4 - 13mm wide
- 16-872-14 fig. 5 - 14mm wide
- 16-873-15 fig. 6 - 15mm wide

**Greene**  
Uterine Curette,  
blunt, serrated blade,  
malleable shaft,  
28 cm

- 16-874-10 10mm wide
- 16-875-12 12mm wide
- 16-876-14 14mm wide



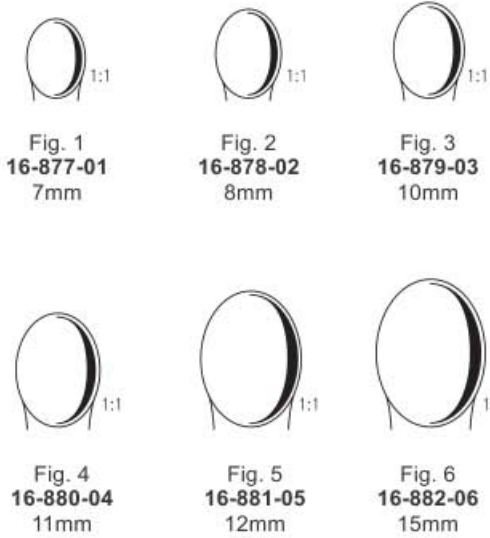

**Schröder**  
**Uterine Scoop**  
25cm

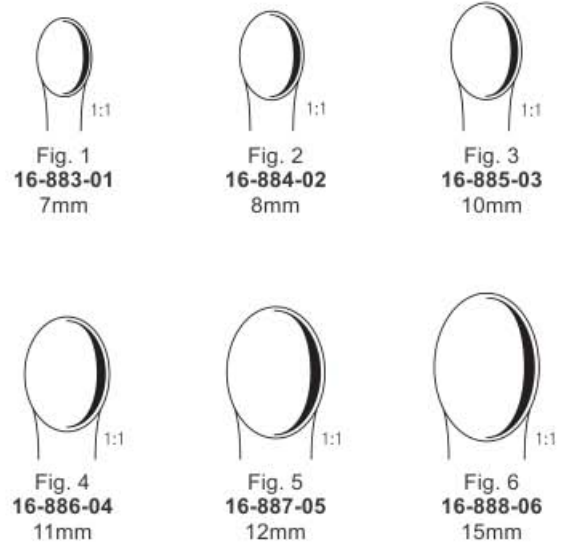

**Schröder**  
**Uterine Scoop**  
30cm

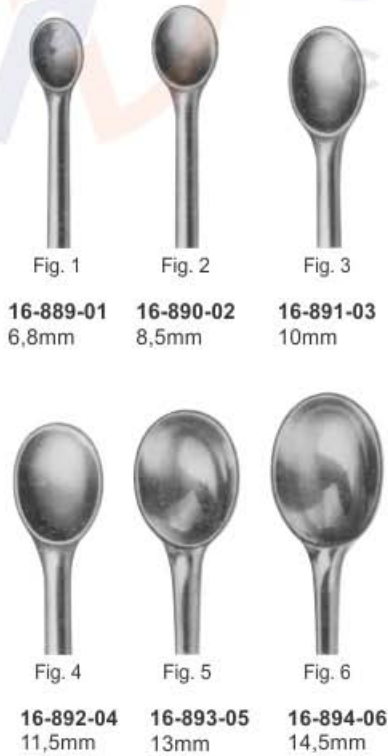

**SIMON**  
**16-889-01 - 16-894-06**  
240mm

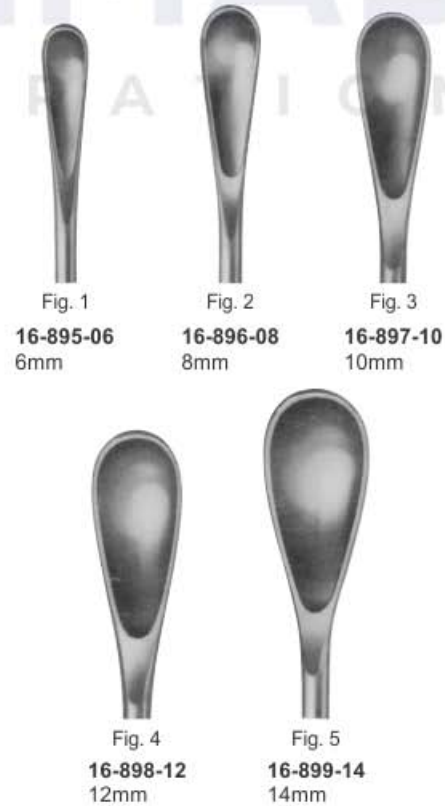
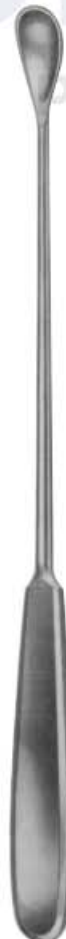

**GOURDET**  
**16-895-06 - 16-899-14**  
Blunt  
280mm



*Hämostatische Uteruszangen, Perforatoren, Nabelschnurzangen und Klemmen*

*Pinzas uterinas hemostáticas, perforadoras, pinzas y pinzas para cordón umbilical*

*Pinces hémostatiques utérines, perforatrices, pinces et pinces pour cordon ombilical*

*Pinza emostatica uterina, perforatore, pinza per cordone ombelicale e pinze*

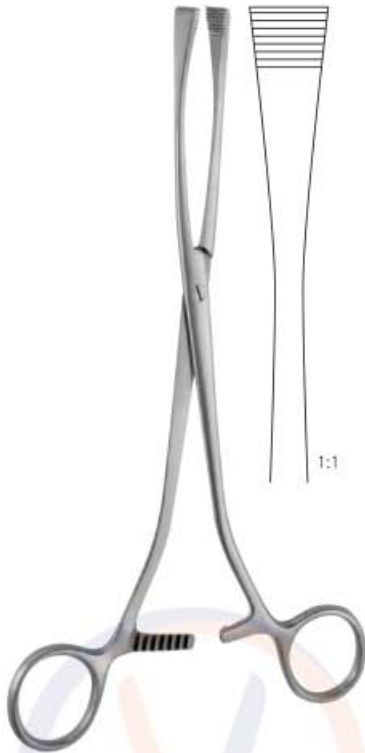

**Green-Armytage**  
Uterine Forceps  
16-900-21 21 cm



**Smellie**  
Perforator  
16-901-25 25 cm



**Naegele**  
Perforator  
16-902-25 25 cm

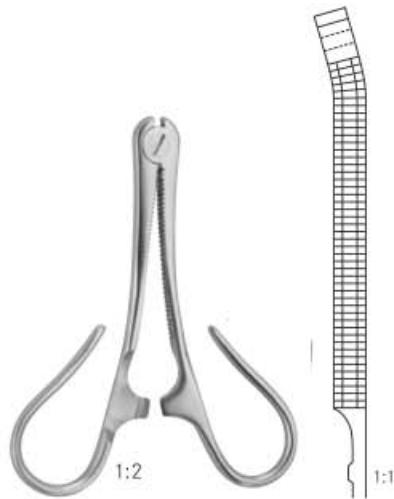

**Kane**  
Umbilical Cord Clamp  
16-903-85  
8.5 cm



**Collin**  
Umbilical Cord Clamp  
16-904-09  
9 cm



**Zimmerman**  
Myotome,  
SpoonTip,  
16-905-24  
24 cm



**Zimmerman**  
Myotome,  
ChiselTip,  
16-906-29  
29 cm

## PELVIMETER

*Pelvimeter* | *pelvimetro*

*Pelvimètre* | *Pelvimetro*



**Thole Pelvimeter,  
16-907-01**  
for internal and external  
measurements,  
graduated in centimeters



**De Lee Pelvimeter  
16-908-01**  
graduated in centimeters  
and inches



**Collin Pelvimeter  
16-909-01**  
Graduated in  
Centimeters



**Martin Pelvimeter  
16-910-01**  
graduated in  
centimeters



**Schneider Pelvimeter  
16-911-01**  
graduated in centimeters



The additional straight arm  
can be replaced. The pelvimeter  
with straight arm is used for  
localization of the portio vaginalis  
uteri and of vaginal metastasis.



**Breisky Pelvimeter  
16-912-01**  
graduated in  
centimeters



**Simpson**  
Obstetrical Forceps  
16-913-23 23 cm  
16-914-30 30 cm  
16-915-33 33 cm  
16-916-36 36 cm



**Simpson - Braun**  
Obstetrical Forceps  
16-917-33 33 cm  
16-918-36 36 cm



**Naegele**  
Obstetrical Forceps  
16-919-36 36 cm  
16-920-40 40 cm



**Piper**  
obstetrical forceps  
16-921-44 44 cm



**Simpson - Luikart**  
Obstetrical Forceps  
16-922-36 36 cm



**Wrigley**  
Obstetrical Forceps  
16-923-25 25 cm  
16-924-28 28 cm  
for caesarian section



**De Lee**  
obstetrical forceps  
16-925-30 30 cm



**De Lee**  
obstetrical forceps  
16-926-36 36 cm



**Elliot**  
obstetrical forceps  
16-927-32 32 cm  
16-928-38 38 cm



**McLean**  
obstetrical forceps  
16-929-36 36 cm



**Kielland**  
Obstetrical Forceps  
16-930-41 41 cm



**Kielland-Luikart**  
obstetrical forceps  
16-931-40 40 cm

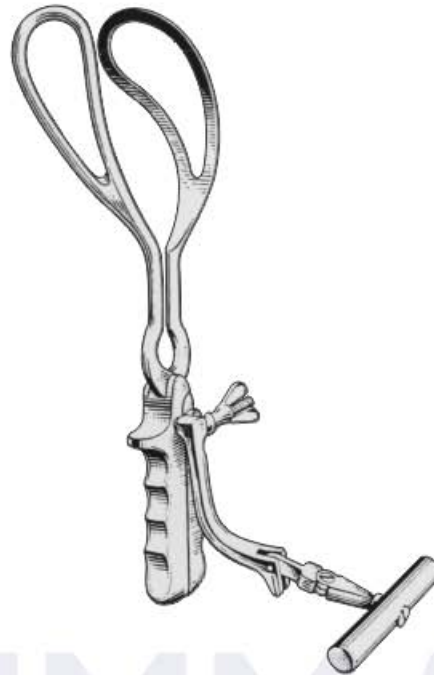

**BARNES-NEVILLE**  
16-932-40 40 cm  
Simpson handles, detachable  
axis traction rod and handle.



**Bil Obstetrical**  
**Holder**  
16-933-00



**Barnes-Neville**  
Obstetrical Forceps  
16-934-43  
with traction  
handle 43.5 cm



**Braun**  
obstetrical forceps  
16-935-42  
42 cm  
Cranioclast, one  
jaw fenestrated



**Tarnier**  
obstetrical forceps  
16-936-46  
46 cm  
Basiotribe



**Sellheim**  
Obstetrical Lever  
16-937-28  
28 cm